

Mark J. Wilson, K1RO, k1ro@arrl.org

Icom IC-R8600 Communications Receiver

A high-performance broadband receiver, with SDR versatility.

Reviewed by Martin Ewing, AA6E
aa6e@arrl.net

Amateurs of a certain age will remember operating with separate receivers and transmitters. At one time, this was the only option. Since the 1970s, however, we generally purchase integrated transceivers. These combine the receiver and transmitter in a single box, simplifying station setup and saving cost.

Why would you consider a standalone communications receiver today? Advanced amateur-friendly models, such as the IC-R8600, cover a very wide frequency range and support a variety of signal modulations and operating modes. They allow you to scan wide swaths of spectrum, looking for interesting signals and diagnosing interference. In one compact box, you get a very good receiver for ham communications, a fine scanning monitor and shortwave listening (SWL) radio, and an excellent piece of test equipment. A receiver in this category will probably not be your first radio, but it can round out the capabilities of any ham shack.

I used the earlier IC-R8500 for many years. Produced between 1996 and 2004, that radio covered 100 kHz to 2 GHz.¹ When it departed my shack, it left quite a gap — and seller's



scanning across wide bandwidths, searching for signals of interest that may have unknown frequencies.

Technical Overview

The IC-R8600 receiver covers the RF spectrum from 10 kHz to 3000 MHz, with the usual US cell phone exclusions.

Figure 1 shows a simplified block diagram.

remorse! Now, after 13 years, Icom's R8000 series resumes with the IC-R8600. The latest advances in software-defined radio (SDR) have brought many high-end features into the R8600's price range. This radio compares favorably with Icom's IC-R9500, now 11 years on the market and aimed at professional users at a higher price point.²

In addition to the classic communications receiver and spectrum analyzer that monitors specific channels or bands, the R8600 is also a "scanner" radio, where the emphasis is on rapid

between 10 kHz and 30 MHz are direct sampled for SDR processing. Above 30 MHz, the radio converts the signal frequency two or three times in a double or triple superheterodyne scheme. To reduce spurious responses, some 11 RF band-pass filters (BPFs) are provided for HF bands, and 13 filters for the VHF/UHF bands. The analog/digital converter (A/D) samples at 122.88 MHz. A field programmable gate array (FPGA) converts the time samples to the frequency domain, for display on the spectrum scope (aka panadapter/waterfall display) or for further digital signal processing (DSP) and digital/analog conversion to produce a demodulated audio signal.

As shown, there are three available antenna inputs. A type-N connector supports the radio's full frequency range. When you are operating below 30 MHz, you can instead select a UHF or a phono connector. The N and UHF

Bottom Line

Covering 10 kHz through 3 GHz and demodulating many popular analog and digital modes, the IC-R8600 can be used as a high-quality ham band receiver, or for listening to many other radio services. Its dynamic performance rivals top-tier amateur transceivers.

Icom IC-R8600 Key Measurements Summary

20 kHz Reciprocal Mixing Dynamic Range (dB)

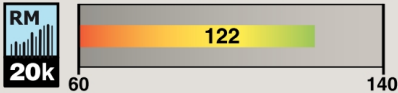

20 kHz Blocking Gain Compression (dB)

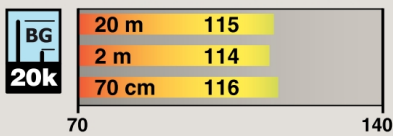

20 kHz Third-Order IMD Dynamic Range (dB)

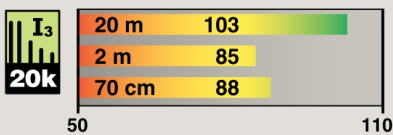

2 kHz Reciprocal Mixing Dynamic Range (dB)

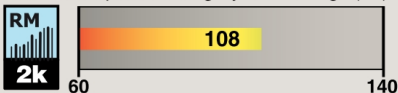

2 kHz Blocking Gain Compression (dB)

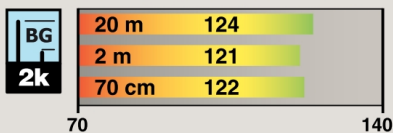

2 kHz Third-Order IMD Dynamic Range (dB)

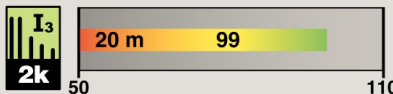

FM Sensitivity (12 dB SINAD, μ V)

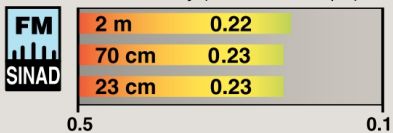

FM 10 MHz Third-Order IMD Dynamic Range (dB)

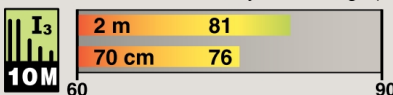

FM 20 kHz Third-Order IMD Dynamic Range (dB)

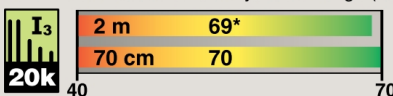

FM Adjacent Channel Rejection (dB)

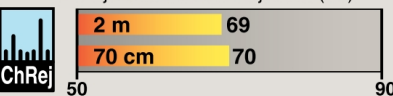

KEY: QS1711-PR121
Dynamic range measurements with receiver preamp off.
Third-order IMD measurements with IP+ on.
FM sensitivity measurements with preamp on.
*Noise limited at value shown.

Table 1
Icom IC-R8600, serial number 02001068

Manufacturer's Specifications

Frequency coverage: 0.01 – 821.999.999, 851 – 866.999999 MHz, 0.896 – 3.0 GHz.
Power requirement: 13.8 V dc, \pm 15%.

Modes of operation: SSB, CW, AM, FM, WFM, FSK, D-STAR, P25, NXDN, dPMR, and DCR.

Measured in the ARRL Lab

As specified.

At 13.8 V dc: 1.49 A (maximum volume, no signal). Off, 8 mA.
As specified.

Receiver

Sensitivity (MDS): Preamp on, 500 Hz BW, 0.1 – 1.8 MHz, –113 dBm; 1.8 – 30 MHz, –121 dBm; 30 – 2,000 MHz, –117 dBm; 2 – 3 GHz, –115 dBm.

Noise figure: Not specified.

AM sensitivity: For 10 dB (S+N), 6 kHz BW, 0.1 – 30 MHz, 7.96 μ V; 1.8 MHz – 3 GHz, 6.32 μ V.

FM sensitivity: For 12 dB SINAD, 15 kHz BW, 28 MHz – 2 GHz, 0.5 μ V; 2 – 3 GHz, 0.8 μ V.

Blocking gain compression dynamic range: Not specified.

Reciprocal mixing dynamic range (500 Hz BW): Not specified.

ARRL Lab Two-Tone IMD Dynamic Range Testing (500 Hz bandwidth)[†]

Band/preamp	Spacing	Measured IMD Level	Measured Input Level	IMD DR
3.5 MHz/Off	20 kHz	–131 dBm –97 dBm	–32 dBm –7 dBm ^{††}	99 dB
14 MHz/Off	20 kHz	–132 dBm –97 dBm	–29 dBm –14 dBm ^{††}	103 dB
14 MHz/On	20 kHz	–142 dBm –97 dBm	–39 dBm –33 dBm ^{††}	103 dB
14 MHz/Off	5 kHz	–132 dBm –97 dBm	–33 dBm –19 dBm ^{††}	99 dB

Receiver Dynamic Testing

Noise floor (MDS), 500 Hz bandwidth:

	Preamp off	Preamp on
0.137 MHz	–126 dBm	–136 dBm
0.475 MHz	–128 dBm	–138 dBm
3.5 MHz	–131 dBm	–141 dBm
14 MHz	–132 dBm	–142 dBm
28 MHz	–132 dBm	–142 dBm
50 MHz	–133 dBm	–141 dBm
70 MHz	–133 dBm	–142 dBm
144 MHz	–133 dBm	–141 dBm
222 MHz	–133 dBm	–141 dBm
432 MHz	–133 dBm	–141 dBm
902 MHz	–131 dBm	–138 dBm
1,296 MHz	–134 dBm	–140 dBm
2,300 MHz	–133 dBm	–137 dBm

14 MHz, 5 dB; 144 MHz, 6 dB; 432 MHz, 6 dB; 1.3 GHz, 7 dB; 2.3 GHz, 10 dB.

For 10 dB (S+N/N), 6 kHz bandwidth:

	Preamp off	Preamp on
1.020 MHz	1.74 μ V	0.65 μ V
3.885 MHz	1.82 μ V	0.60 μ V
29.0 MHz	1.78 μ V	0.50 μ V
50.4 MHz	1.64 μ V	0.68 μ V
120 MHz	1.64 μ V	0.68 μ V
144 MHz	1.64 μ V	0.68 μ V
430 MHz	1.74 μ V	0.68 μ V

For 12 dB SINAD, 12 kHz bandwidth:

	Preamp off	Preamp on
29 MHz	0.50 μ V	0.21 μ V
52 MHz	0.51 μ V	0.22 μ V
70 MHz	0.76 μ V	0.20 μ V
100 MHz	0.94 μ V	0.41 μ V (WFM)
146 MHz	0.53 μ V	0.22 μ V
162 MHz	0.54 μ V	0.24 μ V
223 MHz	0.57 μ V	0.23 μ V
440 MHz	0.56 μ V	0.23 μ V
902 MHz	0.71 μ V	0.29 μ V
1,296 MHz	0.41 μ V	0.23 μ V

Blocking gain compression dynamic range, 500 Hz bandwidth:

	20 kHz offset	5/2 kHz offset
	Preamp off/on	Preamp off
3.5 MHz	123/113 dB	123/124 dB
14 MHz	124/115 dB	124/124 dB
50 MHz	122/114 dB	122/122 dB
144 MHz	121/114 dB	121/121 dB
440 MHz	122/116 dB	122/122 dB

14 MHz, 20/5/2 kHz offset: 122/114/108 dB.

Manufacturer's Specifications

Measured in the ARRL Lab

<i>Band/preamp</i>	<i>Spacing</i>	<i>Measured IMD Level</i>	<i>Measured Input Level</i>	<i>IMD DR</i>
14 MHz/Off	2 kHz	-132 dBm -97 dBm	-33 dBm -19 dBm††	99 dB
50 MHz/Off	20 kHz	-133 dBm -97 dBm	-50 dBm -24 dBm	83 dB
50 MHz/On	20 kHz	-141 dBm -97 dBm	-55 dBm -35 dBm	86 dB
144 MHz/Off	20 kHz	-133 dBm -97 dBm	-48 dBm -28 dBm	85 dB
144 MHz/On	20 kHz	-141 dBm -97 dBm	-56 dBm -35 dBm	85 dB
432 MHz	20 kHz	-131 dBm -97 dBm	-43 dBm -33 dBm	88 dB
Spectral sensitivity: Not specified.		Waterfall and panoramic display, preamp off/on, -107/-121 dBm.		
Tuning dial accuracy: Not specified.		Standalone, without 10 MHz reference signal input, with tuning dial set to 10 MHz, 0 Hz; 50 MHz, +12 Hz; 500 MHz, +122 Hz; 1 GHz, +245 Hz; 2 GHz, +488 Hz; 3 GHz, +730 Hz. (Tuning dial reads high by listed amount.)		
Second-order intercept point: Not specified.		Preamp off/on: 14 MHz, +71/+67 dBm; 21 MHz, +77/+59 dBm; 50 MHz, +85/+85 dBm; 144 MHz, +65/+65 dBm; 432 MHz, +91/+79 dBm.		
FM adjacent channel selectivity: Not specified.		29 MHz, 85 dB; 52 and 70 MHz, 68 dB; 144 and 223 MHz, 69 dB; 440 MHz, 70 dB.		
FM two-tone third-order dynamic range: Not specified.		20 kHz spacing: 29 MHz, 85 dB*; 52 and 70 MHz, 68 dB*; 144 MHz, 69 dB*; 223 MHz, 69 dB*; 440 MHz, 70 dB. 10 MHz spacing: 29 MHz, 91 dB, 52 MHz, 79 dB; 70 MHz, 91 dB; 144 MHz, 81 dB; 223 MHz, 84 dB; 440 MHz, 76 dB.		
Squelch sensitivity: Not specified.		Preamp on: 29 MHz, 0.09 µV; 52 MHz, 0.13 µV; 70 MHz, 0.11 µV; 144 and 223 MHz, 0.12 µV; 440, 902, 1,296 MHz, 0.13 µV; maximum squelch ≥13 mV. SSB squelch, preamp off: 14 MHz, 2.06 µV.		
Signal strength meter accuracy: Not specified.		For S-9 level input, preamp off/on: 14 MHz, 82.1/31.6 µV; 50 MHz, 82.1/33.1 µV; 144 MHz, 78.4/43.6 µV; 432 MHz, 88.0/40.2 µV; 1 GHz, 132/55.5 µV; 2 GHz, 184/146 µV; 3 GHz, 103/65.2 µV. 5 dB.**		
DSP noise reduction: Not specified.		Manual notch, 57 dB; auto notch, >65 dB.		
Notch filter depth: Not specified.		Range (bandwidth) at -6 dB points:‡ CW (500 Hz): 344 – 851 Hz (507 Hz)		
IF/audio response: Not specified.		USB: (2.4 kHz): 242 – 2,750 Hz (2,408 Hz) LSB: (2.4 kHz): 242 – 2,750 Hz (2,408 Hz) AM: (6 kHz): 150 – 3,150 Hz (6,000 Hz).		
Audio output: 2 W at 10% THD, 8 Ω load.		2.3 W at 10% THD into 8 Ω. THD at 1 V _{RMS} , 0.4%.		
Signal processing delay time: Not specified.		15 ms.		
Size (height, width, depth): 4.0 × 8.6 × 10.5 inches (including protrusions). Weight: 9.5 lbs.				
Price: IC-R8600, \$2,499; AD-55NS power supply, \$59; CS-R8600 programming software, \$80.				

†Third-order IMD dynamic range data taken with IP+ on. See Lab Notes sidebar.
 ††-97 dBm (S-5) level measurements taken at threshold of ADC overload.
 *Measurements are noise limited at the value indicated.
 **See Lab Notes sidebar.
 ‡Default values; bandwidth and cutoff frequencies are adjustable.

connectors support a 50 Ω coax connection, while the phono jack is nominally 500 Ω, intended for long-wire (probably non-resonant) antennas.

You can direct audio output to a built-in or external speaker, a headphone jack, a constant-level “line” output, or as digital audio to your computer or other device over USB or ethernet. You can view digital mode decoded text output on screen, or you can direct output to an external device COM port over USB. You may also store up to 32 GB of video screenshots, audio, or decoded data on an SD memory card.

The R8600 will internally decode FSK (RTTY) signals, along with a number of data modes. For ham use, the radio’s main data mode of interest is probably D-STAR. Other modes (P25, NXDN, dPMR, and DCR) are generally used by other radio services. Unfortunately, there is no support for the digital voice modes DMR or C4FM (Yaesu System Fusion) or other common data modes, such as PSK31.

The radio offers a number of extra signal output options. An analog 10.7 MHz IF output with 10 MHz fixed bandwidth, allows you to connect alternative back-end equipment. There is a dedicated USB jack for output of complex I/Q IF data, and a 12 kHz digital IF output can be taken from a 1/8-inch phone jack or either a front or rear USB connection.

User Interface

A key feature of any modern radio gear is the user interface. With SDR techniques, you can control and monitor operation through a full complement of buttons, knobs, touchscreens, or even from remote computers. The R8600 controls closely resemble other recent Icom products, such as the IC-7300, so many users will find the scope, memory, and scan system very familiar.

The R8600 sports an attractive 4.3-inch color touchscreen display that can be configured to show operating condi-

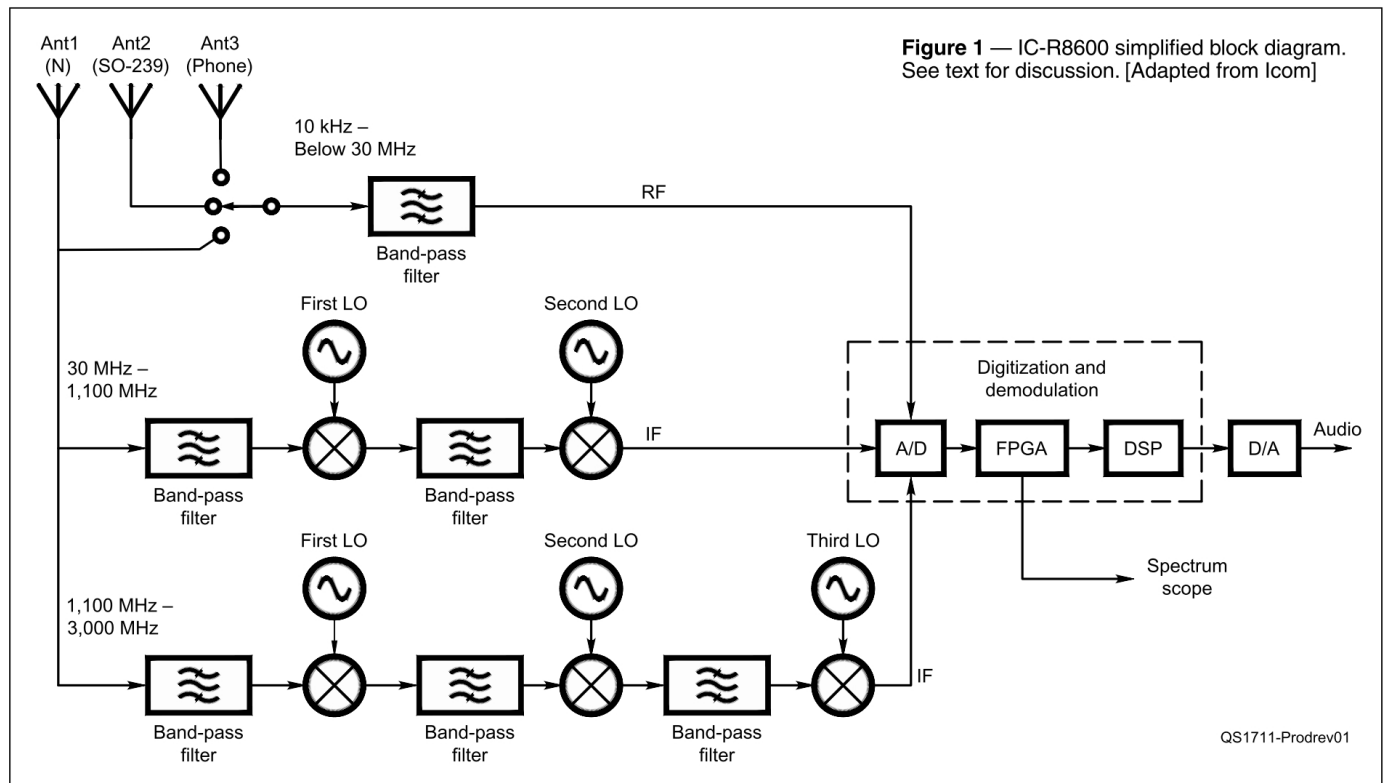

tions. There is also a spectrum scope/waterfall that will show up to 5 MHz of spectrum typically centered on the current operating frequency. You can narrow the spectrum display range down to 5 kHz, giving a useful frequency resolution of about 10 Hz, which is the minimum VFO step size. (VFO resolution is actually 1 Hz, but 10 Hz is the step accessible from the normal controls. You can get 1 Hz settings via the touchscreen “zoom” function.)

If you want to preserve a screen display, there is a convenient screenshot option to store .png or .bmp files with 480 × 272 resolution on an SD card. Alas, there is no support for an external video display. There is, however, an output to drive an external signal strength meter.

Three multifunction (turn/push) controls are assigned to scanning control (Dial A), audio/RF gain and squelch (Dial B), and memory selection (Dial C). Other functions are selected either by screen touches or by physical but-

tons. The main tuning knob has a good feel with three rather different settings — low friction, high friction, and (my favorite) a step detent action.

The signal-strength meter displays as a bar graph that is notable because it supports four different scales. One is the classic “S-meter,” which displays S-1 to S-9 and up to S-9 + 60 dB. This is meant to observe the normal convention that S-9 is 50 μ V, with a change of 1 S-unit corresponding to 6 dB, although the R8600 did not conform to this convention (see the “Lab Notes” sidebar). You can alternatively select a dBm scale that shows 0 dBm for a 1 mW input level. Unlike the S-meter, the dBm reading does not vary as you switch in the preamp or attenuators. It is meant to represent the actual power level at the input connector. You can also view absolute voltage (dB μ) in either 50 Ω terminated or open-circuit modes.

Other Features

The 10 MHz internal frequency refer-

ence is specified to be better than ± 0.5 ppm. A back panel connector will supply this reference to external equipment. Optionally, this connector can accept a reference from an external 10 MHz source. Note that a 1 ppm offset at 3 GHz is 3 kHz, so a high-quality external reference may be needed if you want full accuracy and stability at the highest frequencies.

The R8600’s internal clock can be synchronized to an external internet NTP (Network Time Protocol) server through an ethernet connection. The same ethernet connection should support remote control operation, which Icom says is coming in a future software product.

If you set up the receiver’s antenna port and preamp, attenuator, and IP+ settings at a particular frequency, how far can you tune away from that frequency before the settings might change?

This is not discussed in the *Instruction Manual* (but should have been), so I experimented and found that the radio

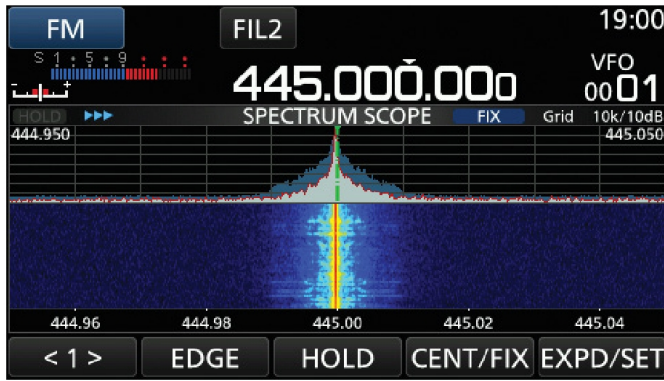

Figure 2 — A UHF FM voice transmission.

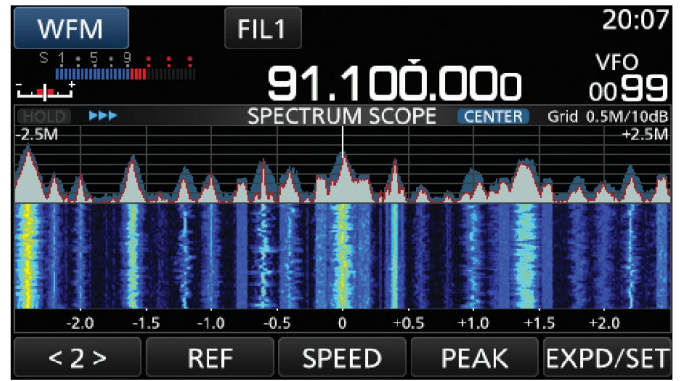

Figure 3 — Spectrum of FM broadcast signals.

divides up the spectrum into “bands.” If you change any of those settings anywhere within a particular band, they seem to apply all throughout the band. I found band edges at 1.6, 2, 6, 8, 11, 15, 20, 22, 26, 30, and 1100 MHz. (The low band goes down to 10 kHz, and the high band goes up to 3 GHz.) Presumably, the radio is switching its filters and signal paths at these frequencies also.

You may run into unexpected changes in settings as you tune across a band boundary, but the panel display always shows the active values.

Operating Modes

The R8600 provides full support of the classical modulation modes along with some digital modes. Indirectly, you can supply your own DSP hardware or demodulation software (for example, *Fldigi*) to use the 10.7 MHz IF output, the 12 kHz IF output, or the SSB audio output.

AM operation is supported in four modes. There is AM and synchronous AM (SAM). SAM is provided for upper, lower, and double sideband operation. You can select an IF bandwidth from 200 Hz to 10 kHz. SAM is especially useful when selective fading of the AM carrier would cause audio distortion. The single sideband SAM options allow you to avoid interference that may appear on top of an AM signal in one sideband or the other.

CW operation is supported by IF band-pass adjustable from 50 Hz to 3.6 kHz, with sidetone frequencies (pitch at band-pass center) between 300 and 900 Hz.

SSB (LSB or USB) is supported with IF bandpass from 50 Hz to 3.6 kHz.

FM IF bandpass is fixed at 50 kHz, 15 kHz, or 7 kHz. You get a deviation indicator and an optional automatic frequency control (AFC) that can help you get on frequency (see Figure 2).

WFM (wide FM) is typically used for FM broadcasting. Its bandwidth is fixed at 200 kHz (see Figure 3).

With FSK, you get a tuning indicator and also a useful optional decode display that shows four to nine lines of decoded text alongside an audio spectrum scope that helps you tune in a RTTY station (see Figure 4). Default band-pass settings range from 2.4 kHz down to 250 Hz. Manually, you can set 50 Hz to 2.7 kHz. The decoder supports either 45 or 50 baud RTTY, with a range of standard mark/space tones and shifts. You can record decoded text as a text or HTML file on the SD device, or you can pass the data to your computer over USB.

There are default filter settings (FIL1, FIL2, FIL3) from wider to narrower, as appropriate for each mode. When you adjust filter settings manually, your

new setting temporarily replaces one of the defaults.

The IF band-pass filter in these modes can be set to sharp or soft. Sharp filtering is best for eliminating nearby interference, while soft is preferred as a more traditional sound by some users.

The digital modes decode a number of signaling schemes, but only D-STAR is widespread among amateurs. It was simple enough to monitor a local D-STAR repeater, receiving both voice and text messages.

In addition to IF filtering, you can set different audio tone controls for each mode. That’s a lot of customization!

Signal Processing

For most signal modes, you have the usual receiver controls, resembling other Icom radios. There is an “IP+” mode that greatly increases IMD performance in certain situations — multiple signals in a low noise environment, such as in our Lab tests (see the “Lab Notes” sidebar). Controls for notch filtering, noise blanking, and noise reduction will be familiar. Icom’s digital twin passband tuning (TPBT) allows you to shift and narrow the passband as desired.

Memory and Scanning

The R8600 provides many memory channels that record frequency, mode, antenna setting, and other data associated with a particular receiving setup (a

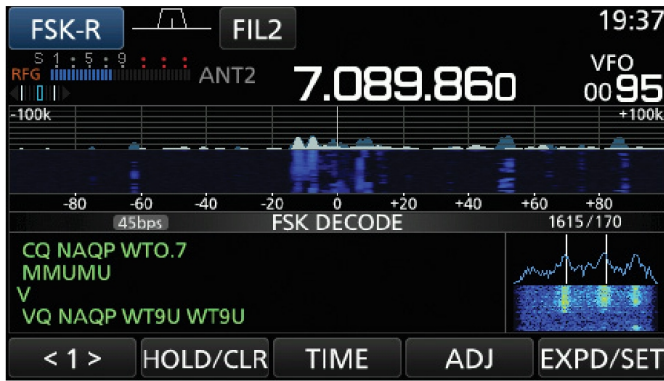

Figure 4 — Spectrum and waterfall of 40-meter RTTY signals, showing decoded text and fine audio spectrum for precise tuning.

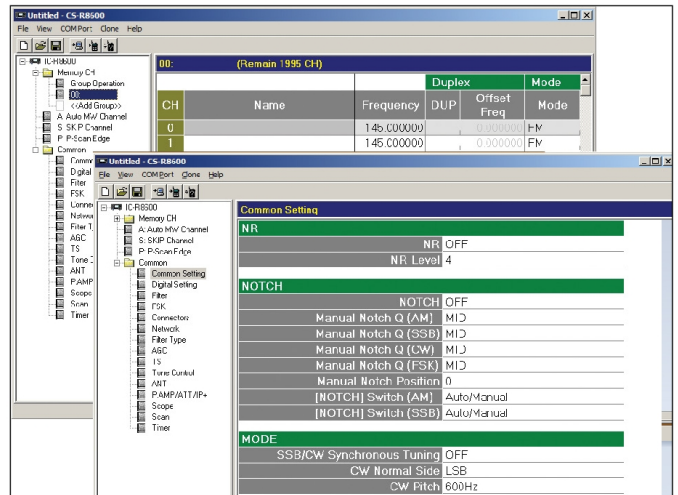

Figure 5 — Screenshots of CS-R8600 software: memory programming (below) and hardware settings (above).

station, in other words). You can set up 100 groups that can each contain 100 channels, up to the overall limit of 2,000 channels.

The R8600 scanning operation is similar to many other radios. You can scan predefined memory channels or defined frequency ranges. You can search for activity over a frequency range and store the active frequencies in memory channels.

It is interesting to note that the search function listens to one channel at a time, so it can take a long time to cover a wide band, stepping at a rate of 50 channels per second or less. If we made full use of the SDR's FFT capability, we should be able to search hundreds of channels in parallel, cutting search time dramatically. Maybe in the future!

Cloning Software

You can manage the R8600 for routine tasks from the front panel. However, that gets tedious for such a complex radio with its 2,000 memory channels. To configure the radio and especially to “clone” the settings from one radio to another, you need computer assistance. Icom provides the *CS-R8600 Cloning Software* (\$79.95) just for this purpose (see Figure 5). Any computer running *Windows Vista* or above with

USB or SD card capability should support the software. I checked for alternative free cloning programs, but could find none that support the R8600 at this time.

Updates

There are several upgradable software components in the R8600. The manual gives clear update instructions that allowed us to update the main CPU using an external computer and SD card. (It would have been handier if the R8600 could update itself over its ethernet connection, but this is not supported.) For this review, we used the following firmware versions: Main CPU 1.10; Front CPU 1.00; DSP Program 1.02; FPGA 1.00, and DV DSP 1.00. If you have the *CS-R8600* software, you will need to update it to the same level.

Note that you should check Icom's Japan site (www.icom.co.jp/world/support/) for manuals and firmware updates. Icom's American website (www.icomamerica.com) may not have the latest files.

The R8600 is ruggedly built, allowing Icom to claim MIL-STD-810 compliance.³ Dissipating up to 25 W, the radio can run warm to the touch, but requires no special ventilation.

Wrap-Up

As an ultra-versatile receiver, the Icom IC-R8600 may not be optimized for any particular service. For convenience and price, a fully integrated SDR transceiver will still be most amateurs' choice for operating. If you want to use it on the higher UHF and microwave bands, you will need a more sensitive preamplifier.

Some of the more interesting features (ethernet, I/Q outputs) do not have support from Icom software as this is written. You will have to wait for remote control, for example, or start coding your own software.

Still, the R8600 is a remarkable radio that serves many applications beyond ham radio. In an amateur's shack, the R8600 will provide access to a big swath of spectrum that includes all the ham frequencies from dc through the 13-centimeter band. It can be used as a high-quality ham band receiver, but it is much more than that. You can check out all the radio services up to 3 GHz. It is also excellent test equipment that will let you check spurious emissions and locate interference sources.

The receiver has a significant learning curve if you want to master all its features, but its similarity to other Icom

IC-R8600

10kHz - 3GHz SDR Communications Receiver

- Ultra-wide frequency coverage with RSSI
- Real-time spectrum scope
- Decodes multiple digital protocols
- Touch screen display
- Clear audio quality using FPGA/DSP base architecture
- I/Q signal output for use with third-party SDR software
- The SD card slot and voice recording
- Optional SP-39AD external speaker with integrated power supply
- Optional RS-R8600 remote control software



Listen to the World

Information & Downloads

[AMATEUR TOOL KIT](#) | [COMIC BOOKS](#) | [VIDEOS](#) | WWW.ICOMAMERICA.COM

Electronic advertisements feature active links.

©2017 Icom America Inc. The Icom logo is a registered trademark of Icom Inc. All other trademarks remain the property of their respective owners. All specifications are subject to change without notice or obligation. 31190

ICOM[®]



Lab Notes: Icom IC-R8600 Communications Receiver

Bob Allison, WB1GCM, ARRL Assistant Laboratory Manager

The IC-R8600 receiver is small in size, but a giant in performance. It uses direct sampling below 30 MHz, dual conversion from 30 to 1100 MHz, and triple conversion from 1.1 to 3 GHz. Overall, sensitivity is very good to excellent above 15 kHz, all the way to 3 GHz. Sensitivity drops off to more than 1 μ V below 15 kHz.

The lowest of the three dynamic ranges, as typically measured in our laboratory, is 99 dB (third-order IMD dynamic range at 14 MHz with 2 kHz spacing), rivaling some of the top-tier amateur band transceivers on the market. This high dynamic range is possible only when the IP+ function is on, which turns on an internally generated dither signal. With it off, expect this measurement to be around 60 dB.

On the FM side, adjacent-channel rejection is very good with a receive bandwidth of 15 kHz. Switching to Filter 3 in this mode narrows the bandwidth to 7 kHz and provides an extra 4 dB of rejection.

Second-order IMD dynamic range is very good to excellent. Direct sampling receivers can be deficient in this department, with strong signals adding up to create false signals on another frequency. For example, a strong 6 MHz signal and a 15 MHz signal at the antenna jack can create a false signal at 21 MHz — not so with the R8600, unless you live close to an active shortwave broadcast facility. With the antenna disconnected, I hunted for birdies until my finger fell off, and found only a few in the HF and VHF spectrum; one birdie, understandably, was found at 10.7 MHz. I will leave it up to the user to hunt for the few other birdies hiding among the GHz.

No IF bleed-through or images were detected for input levels up to +10 dBm. Below 30 MHz, there are occasions when ADC overload occurs. For example, a signal above -13 dBm,

or two signals at -19 dBm, resulted with an overload indication during testing. If the user experiences such signals (-13 dBm is 60 dB over S-9), the attenuator can be used to clear the overload.

The noise reduction feature reduced the background noise in relation to the desired signal by 5 dB. Though this may seem deficient by measurement, the user will find the level of noise reduction, by ear, to be good — more than indicated by our lab measurement.

Tuning dial accuracy was good, considering the wide tuning range of the R8600. It was off by less than 1 kHz at 3 GHz. With the use of an outboard GPS-locked 10 MHz reference signal, the tuning dial should be spot on.

Signal strength meters give an indication of the level of signal reaching the antenna jack at the tuned frequency. We are all familiar with the S-meter; its desired accuracy requires a -73 dBm (50 μ V) signal for an S-9 indication, with 6 dB per S-unit below that level. The S-meter *should not* read higher with the preamp on. With the R8600, the S-meter does not meet this standard. The S-9 level varies from band to band. The meter is calibrated to about 4 dB per S-unit, and it reads higher when the preamp is switched on.

For those who get tied in a knot about such things, don't worry. Signal strengths can also be measured in dBm and microvolts. Lab measurements found both scales to read close to the output of our Lab's signal generators. Best yet, the signal strength readings with the preamp on and off were the same or nearly the same. I like that.

Finally, the squelch threshold control of the R8600 has a wide range — nearly 95 dB! Icom certainly understands the need for a usable squelch range.

products will help many users get in the swing pretty quickly.

Manufacturer: Icom America,
12421 Willows Rd. N.E., Kirkland,
WA 98034; tel. 800-872-4266;
www.icomamerica.com.

Notes

¹B. Moore, NC1L, "Icom IC-R8500 Communications Receiver," Product Review, *QST*, Apr. 1997, pp. 61 – 64.

²D. Newkirk, AB2WH, "Icom IC-R9500 Communications Receiver," Product Review, *QST*, Jan. 2008, pp. 69 – 73.

³See en.wikipedia.org/wiki/MIL-STD-810. The ARRL Lab does many tests, but we do not check shock and vibration resistance.



Visit <https://youtu.be/hTproxYcPyM>
to see our review of the Icom IC-R8600
Communications Receiver on YouTube.



THE NETHERLANDS | Roermond
Tel. +31 (0)475-327390
www.classicinternational.eu

GERMANY | Mönchengladbach
Tel. +49 (0)2166-33061
www.classicinternational.eu